

CIRC. 637

GEOLOGICAL SURVEY CIRCULAR 637-A, B



A Preliminary Study of the Effects of Water Circulation in the San Francisco Bay Estuary

Prepared in cooperation with the U.S. Department of Housing and Urban Development

A Preliminary Study of the Effects of Water Circulation in the San Francisco Bay Estuary—

Some Effects of Fresh-water Inflow
on the Flushing of South
San Francisco Bay

By D. S. McCulloch, D. H. Peterson, P. R. Carlson, and T. J. Conomos

Movement of Seabed Drifters in
the San Francisco Bay Estuary
and the Adjacent Pacific Ocean

By T. J. Conomos, D. H. Peterson, P. R. Carlson, and D. S. McCulloch

GEOLOGICAL SURVEY CIRCULAR 637-A, B

*Prepared in cooperation with the
U.S. Department of Housing and
Urban Development*



United States Department of the Interior
WALTER J. HICKEL, *Secretary*



Geological Survey
William T. Pecora, *Director*



Free on application to the U.S. Geological Survey, Washington, D.C. 20242

FOREWORD

There is a growing national awareness of the value of major estuaries like San Francisco Bay as important coastal assets and an appreciation for the complicated natural processes that take place within them. We must understand these natural systems better in order to respond to competing demands for the use of an estuary.

The millions of people in the cities that surround San Francisco Bay depend in one way or another upon the water in the bay for recreation, commerce, waste emplacement, biota balances, or aesthetic enjoyment. Such uses are contingent in varying degree upon the rate with which human or natural processes add materials to or remove them from the estuary. The purpose of this report is to provide information that will lead to a better understanding of the ecosystem of San Francisco's south bay, to indicate significant geochemical balances, to help predict consequences of man's activities, to suggest solutions to existing or potential problems, and to insure wise use of this invaluable natural resource.

Water-quality characteristics of south bay are influenced primarily by inflow of fresh water, manmade wastes, and tidal exchanges of water of varying salinity. Changes in any of these controls could have significant effects on the overall quality of the bay. This report qualitatively demonstrates that high and low seasonal inflows of fresh water to the bay's Sacramento River delta correlate inversely with salinity and phosphate concentration in the south bay. It suggests that net fresh water flow to the bay from this source is a major quality control under present conditions. Additional investigations are warranted to establish long-term significance of this suggested coupling.



W. T. Pecora,
Director

Some Effects of Fresh-water Inflow on the Flushing of South San Francisco Bay: A Preliminary Report

By D. S. McCulloch, D. H. Peterson, P. R. Carlson, and T. J. Conomos

A PRELIMINARY STUDY OF THE EFFECTS OF WATER CIRCULATION
IN THE SAN FRANCISCO BAY ESTUARY

GEOLOGICAL SURVEY CIRCULAR 637-A

*Prepared in cooperation with the
U.S. Department of Housing and
Urban Development*



CONTENTS

Introduction -----	Page
Salinity -----	A1
Flushing of the south bay -----	3
Phosphate -----	13
Summary -----	15
Appendix -----	18
	20

ILLUSTRATIONS

Figure 1. Index map of the San Francisco Bay estuary showing locations of water sampling stations -----	Page
2. Graph showing comparison of the salinity changes at two stations in the south bay and the Golden Gate with the combined discharge of the Sacramento and San Joaquin Rivers and the combined discharge of the south-bay streams and sewage effluent -----	A2
3. Graphs showing total monthly discharge of the Sacramento River and the south-bay streams and sewage effluent, and the corresponding changes in the surface salinity distribution in the south bay -----	4
4. Vertical cross sections showing the salinity distribution along the longitudinal axis of the south bay in December 1969 and January 1970 -----	6
5. Generalized surface salinity model for south San Francisco Bay -----	8
6. Graphs showing comparison between the discharge of the large winter storms in wet and dry years and the corresponding distribution of surface salinities in the south bay -----	8
7. Graph showing highest monthly average salinity for each year during 1940-67 for two stations in the south bay and at the Golden Gate plotted against the total annual discharge for that year -----	9
8. Photograph showing the edge of the turbid low-salinity water that is carried into the south bay by the tide -----	9
9. Graph showing measurements of the salinity made in front of, and just behind, the edge of the low-salinity flow -----	11
10. Diagrammatic model of the salinity gradients and net surface and bottom currents through the major seasonal stages in the San Francisco Bay estuary -----	12
11. Map showing arrows drawn from release to recovery points of plastic markers that moved in near-bottom currents -----	12
12. Graph showing seasonal salinity changes at three south-bay stations and the Sacramento River discharge -----	14
13. Graph showing seasonal distribution of phosphate in south San Francisco Bay -----	16
14. Graphs showing seasonal phosphate changes at three south-bay stations, the Sacramento River discharge, and the amount of phosphate contributed each month to the south bay from the San Jose city sewage plant -----	16
15. Graph showing comparison between the monthly discharge of the Sacramento River at Sacramento from January 1969 to January 1970 and the average and the range of monthly discharge of the Sacramento River at Sacramento from 1950 to 1967 -----	19

A PRELIMINARY STUDY OF THE EFFECTS OF WATER CIRCULATION
IN THE SAN FRANCISCO BAY ESTUARY

Some Effects of Fresh-water Inflow on the Flushing
of South San Francisco Bay:
A Preliminary Report

By D. S. McCulloch, D. H. Peterson, P. R. Carlson, and
T. J. Conomos

INTRODUCTION

The San Francisco Bay estuary (fig. 1) is used by the millions of people who inhabit its shore for municipal and industrial sewage disposal, recreation, commerce, fishing, and as a source of aesthetic pleasure. In large measure such uses depend upon the chemical character or quality of water. For many of these uses, the quality depends upon the balance between the rate with which chemical constituents are added to the estuary and the rate at which they are removed.

The purpose of this report is to make data available to those interested in optimum development of the San Francisco Bay estuary. A clear understanding of this estuary system is necessary for evaluating such things as the ability of the estuary to assimilate agricultural, municipal, and industrial waste products; the relation between the amount of freshwater inflow and the quality of the bay water; and the movement of water masses and entrained material within the estuary.

In geometrically simple estuaries, unlike the San Francisco Bay, freshwater enters the estuary from one end and ocean water from the other. These waters are mixed by several processes within the estuary, principally by tides, and because the river discharge produces a net outflow of these tidally mixed waters, the estuary is flushed.¹ The south bay (as used here, the bay south of the San Francisco-Oakland Bay Bridge) does not enjoy this normal flushing pattern, for there is no large freshwater discharge at its head near San Jose. Instead, the south bay is dependent upon water that enters it from the rest of the estuary system for its flushing.²

Note--Numbered references in text are keyed to numbered items in appendix at end of chapter A.

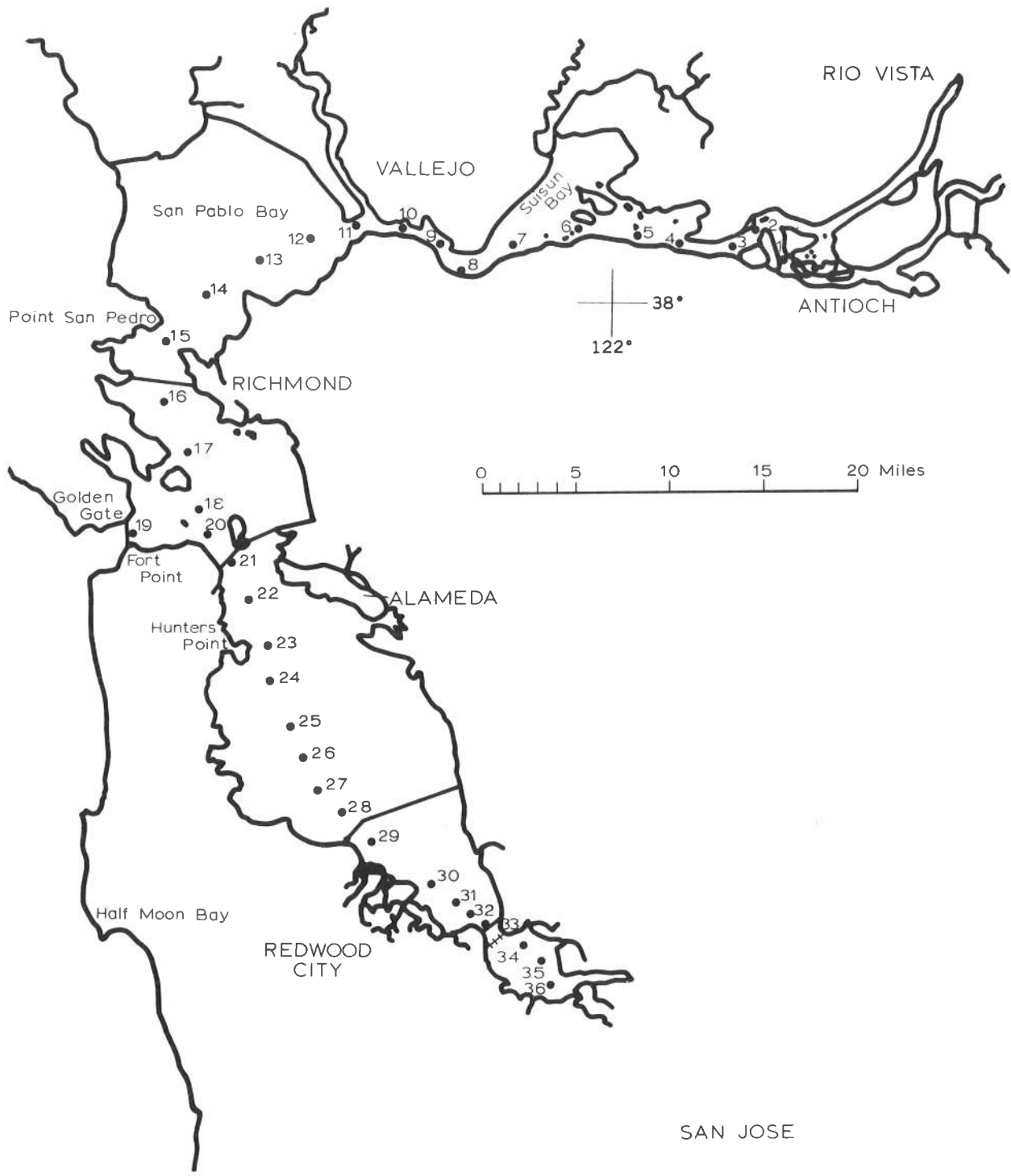

Figure 1.—Index map of the San Francisco Bay estuary showing locations of water sampling stations.

The freshwater discharge of the Sacramento River is the major control of the salinity of San Francisco Bay north of the Oakland Bay Bridge.³ Our analysis of available data indicates that the Sacramento River discharge also controls the seasonal variation in salinity of the south bay.⁴

During years of high rainfall when the Sacramento River discharge is high (unless otherwise noted, "Sacramento River discharge" as used in this text, means the combined waters of rivers discharging into the Sacramento-San Joaquin delta⁵), flushing significantly removes undesirable constituents from the south bay, but in low rainfall years (low Sacramento River discharge) the concentration of pollutants increases, sometimes reaching deleterious levels.⁶ This relation between the degree of flushing of the south bay and the Sacramento River discharge is qualitatively described in this report.⁷ This description is based on preliminary results of our study of short and long-term variations in physical and chemical properties of the water at 36 reoccupied stations in the estuary (fig. 1) and the adjacent Pacific Ocean.⁸ The most useful of these properties are the salinity and the phosphate concentration.

SALINITY⁹

The salinity of San Francisco Bay as a whole is affected by the amount and the salinity of the Pacific Ocean water that enters through the Golden Gate, the amount of water that is discharge into the bay from streams, rivers and sewage outfalls, and by evaporation. The salinity of the bay responds to both seasonal and yearly changes in these factors.

The dilution of Pacific Ocean water entering the Golden Gate by freshwater discharged into the bay largely controls the salinity of the bay water. For example, the mean monthly surface salinity values at three bay stations are shown for a 5 year period on Figure 2. One of these stations (Fort Point) is at the Golden Gate; the other two are in the south bay. Salinities at these three stations ranged from 13 o/oo to 33 o/oo (parts per thousand by weight) throughout this period. This range is considerably larger, and the salinities considerably lower, than the annual range of 32.9 o/oo to 33.8 o/oo of the monthly mean salinity in the adjacent Pacific Ocean.¹⁰ Only during the period of low freshwater discharge in dry years does the surface salinity of the south bay approach or exceed Pacific Ocean salinity.

Evaporation removes a layer of water approximately four feet in thickness each year from the bay.¹¹ If water in the south bay was not exchanged, the salinity would increase by approximately 25%. Because the south bay water is almost always diluted by lower salinity water, the effect of evaporation is considerably reduced. However, as will be discussed later, evaporation can have a marked effect on seasonal salinity variation when the evaporation rate is high during the dry period of low freshwater discharge years.

The discharge of south bay streams and sewage appears to have little effect on the salinity of the south bay. A comparison of total monthly discharge of the Sacramento River and the south bay streams is shown on Figure 2. Included in the south bay discharge is the maximum potential discharge of the existing south bay sewage facilities--which at times is

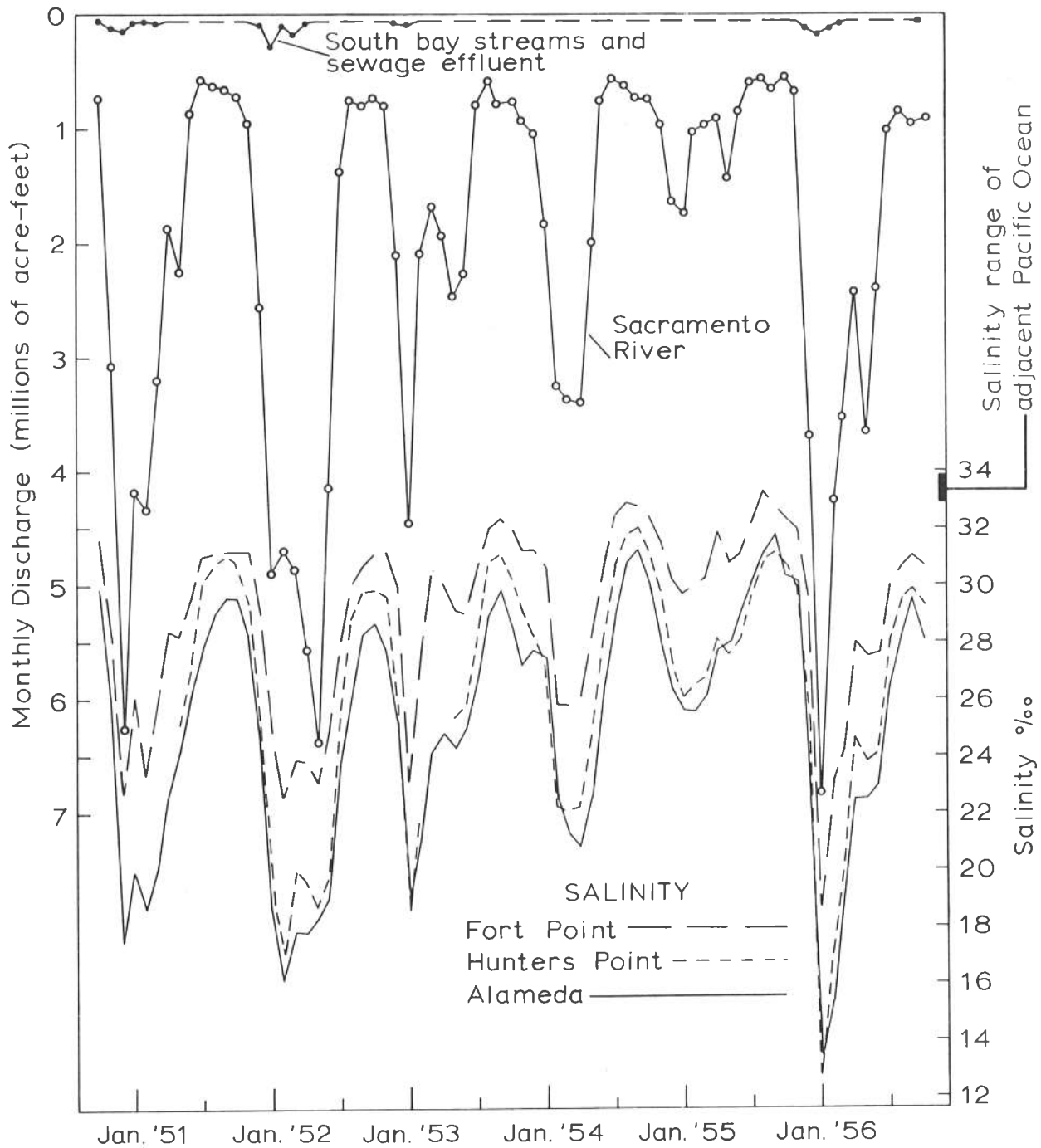

Figure 2.—Comparison of the surface salinity changes at two stations in the south bay (Alameda and Hunters Point) and the Golden Gate (Fort Point) with the combined discharge of the Sacramento and San Joaquin Rivers and the combined discharge of the south bay streams and sewage effluent.^{4b, 5, 12}

much larger than south bay stream discharge.¹² The large difference in the discharge of these two river systems reflects the difference in the size of their drainage basins; the Sacramento - San Joaquin basin is approximately 45,420 square miles, as opposed to the drainage basins of the south bay streams that total approximately 1,850 square miles.¹³

Typically the Sacramento River has two periods of high discharge each year. The first occurs between December and February, and is rainfall runoff in the Sacramento - San Joaquin drainage basin, the second is caused by melting of the snow pack in the Sierras, is shorter in duration, and can occur any time from March through June.¹⁴ South bay streams have a corresponding high winter rain runoff, but have no discharge peak corresponding to the snow melt.

The variations in surface salinity at all stations shown in Figure 2 reflect the Sacramento snow melt discharge that is absent from the south bay streams, even though Hunters Point and Alameda are in the south bay. Thus the south bay salinity is dependent in part on the Sacramento River discharge. In fact, the close correspondence of south bay salinity with major and even minor changes in the Sacramento discharge demonstrates a high degree of dependence throughout this entire period.

A more detailed look at the salinity distribution of the entire south bay over a year's time shows the effect of the Sacramento River discharge more clearly. Throughout the year (January 1969-January 1970), salinity measurements were made on a nearly monthly basis at 36 stations in the bay. Sixteen of these stations are in the south bay (Fig. 1). Salinities were measured at the surface and throughout the water column.⁸

The changing seasonal pattern of the surface salinity in the south bay for 1969 and part of 1970 is shown on Figure 3. On this figure, the stations are located along the vertical axis and time along the horizontal axis. Thus changes in salinity at a station can be read horizontally across the figure, and the changes in position of the salinity contours show the shift in the position of the salinity with time. In order to represent the salinity in terms of the volume of water, each station is plotted on the basis of the volume of water between it and the Oakland Bay Bridge, rather than the actual distance between the stations. This compensated for the narrowing of the south end of the bay.¹⁵

In periods of high Sacramento River winter rainfall discharge (top of Figure 3) low salinity water (less than 8 o/oo salinity, January 1969) entered the south bay from the north. At the same time, or shortly after, the winter rainfall runoff in the south bay streams caused a local decrease in salinity at the south end of the bay (10.6 o/oo salinity, February 1969). This south-end decrease was extremely local and disappeared with the end of the south bay rainfall runoff. During the Sacramento snow melt discharge, that lasted until July, the south bay maintained a relatively low salinity (16 o/oo to 20 o/oo). Then as the Sacramento River discharge decreased the salinity increased, reaching a maximum (30 o/oo) in October. This pattern changed abruptly between December 1969 and January 1970 when the Sacramento discharge increased rapidly, and low salinity water again entered the south bay from the north.

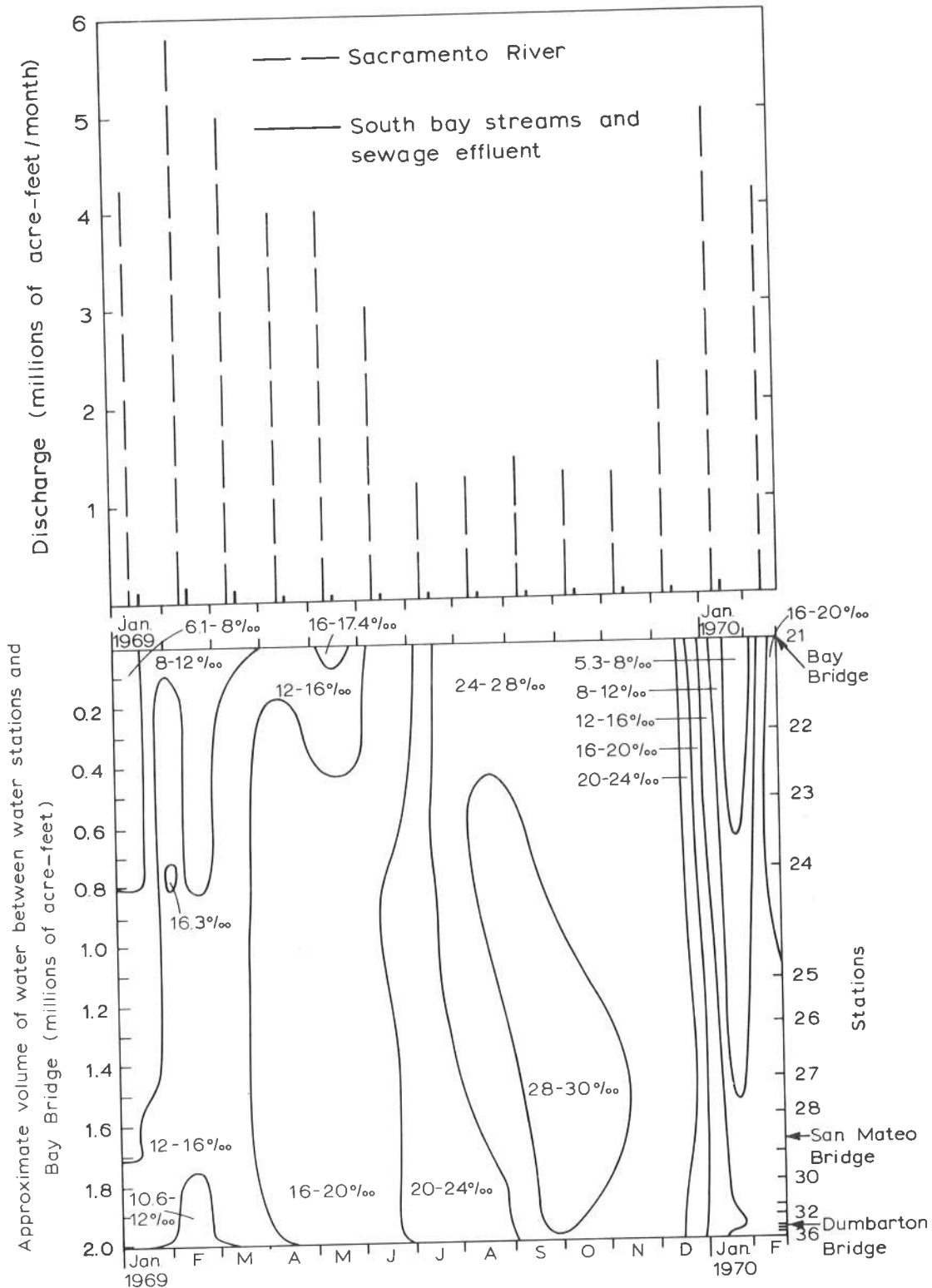

Figure 3.—The total monthly discharge of the Sacramento River and the south bay streams and sewage effluent^{5, 12} upper, and the corresponding changes in the surface salinity distribution in the south bay, lower. The water-sampling stations are shown on the right in terms of the volume of water that lies between the station and the Oakland Bay Bridge.¹⁵

The salinity measurements taken at various depths at the 16 south bay stations allow us to examine the salinity distribution in vertical cross section before and after the rapid December to January salinity change (Fig. 4).¹⁶ It is apparent from these profiles that the salinity of the entire south bay was profoundly changed. It is also clear from the January cross section that the low salinity water came from the north.

The south bay seasonal salinity changes described above can be represented diagrammatically by a three stage model (Fig. 5). In stage 1 (December-February) the low salinity water produced by the high Sacramento rainfall runoff has entered the south bay, and has lowered the surface salinity at the north end. Following this initial discharge of the large winter storms, the low salinity water introduced from the north becomes mixed with the south bay water and reduces the salinity of the south bay. Following stage 1, the Sacramento River discharge decreases, resulting in more saline water just north of the bay bridge. In stage 2 (March-May) this more saline water is introduced into the south bay, and raises the salinity at the north end of south bay. In stage 3 (June-November) the Sacramento and the south bay streams are at their lowest discharges. The average salinity of the south bay is at its highest value; the salinity may become highest in the center of the south bay due to evaporation and there may be a slight lowering of salinity at the north and south ends of the bay due to minor dilution.

During periods of high Sacramento River discharge, then, water that enters the south bay from the north has a large effect on the salinity. Now one might ask, is it possible that the south bay discharge plays a more important role in controlling the south bay salinity when the Sacramento River discharge is low? Or rephrased, can local discharge into the south bay become important enough during low Sacramento discharge to reverse the salinity gradient proposed in the foregoing model? This question is largely answered in Figure 6, on which the discharge from the first major winter storms are compared to surface salinities measured in the south bay. The size of the winter storms largely determines the wetness or dryness of the year. The salinity measurements indicate that salinities increased to the south in dry years as well as wet years. Thus the Sacramento discharge is an important factor controlling the relative salinity distribution of the south bay. This also indicates that stage 1 of the salinity model (Fig. 5) is valid for both wet and dry years.

Although the decrease in Sacramento discharge in dry years does not change the relative salinity distribution of the south bay, it does have a strong effect on the absolute salinity values. This is clearly shown at Golden Gate, Alameda and south of San Mateo on Figure 7. On this figure the highest monthly mean salinity that developed during each year (for the period 1940-1967) is compared with the total discharge for that year. These data show that the lower the yearly river discharge, the higher will be the maximum salinity. It is important to note, that in low discharge years, the salinity of the south bay can exceed that of the adjacent Pacific Ocean. This can only be achieved by evaporation which is, therefore, an important factor during low discharge years.

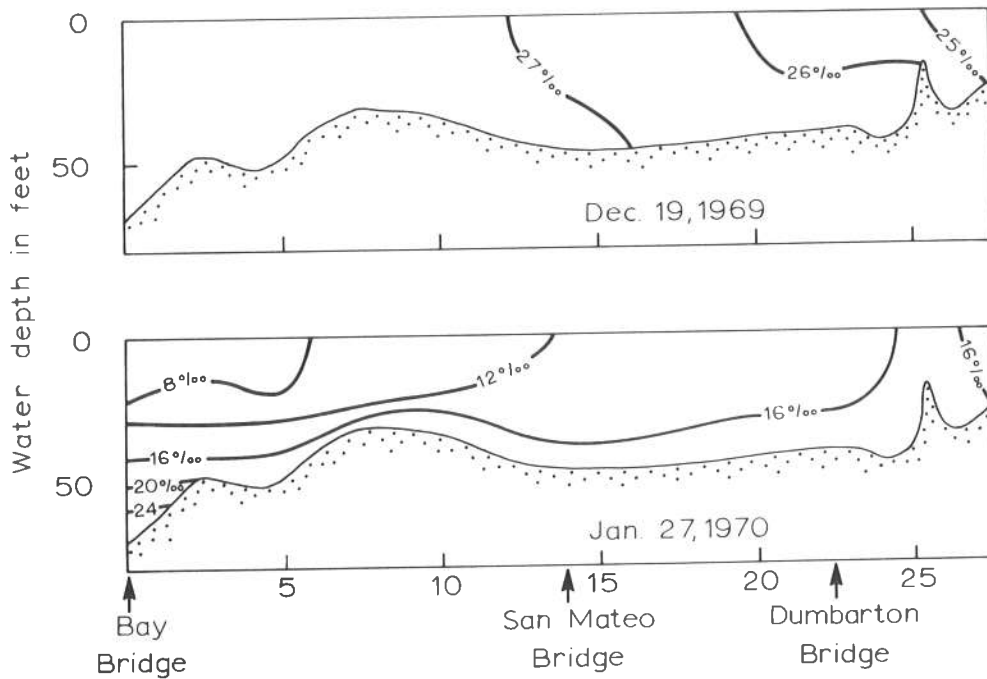

Distance from San Francisco-Oakland Bay Bridge (Nautical Miles)

Figure 4.—Vertical cross-sections showing the salinity distribution along the longitudinal axis of the south bay in December 1969 and January, 1970.¹⁶ (These profiles have a vertical exaggeration of about X 580).

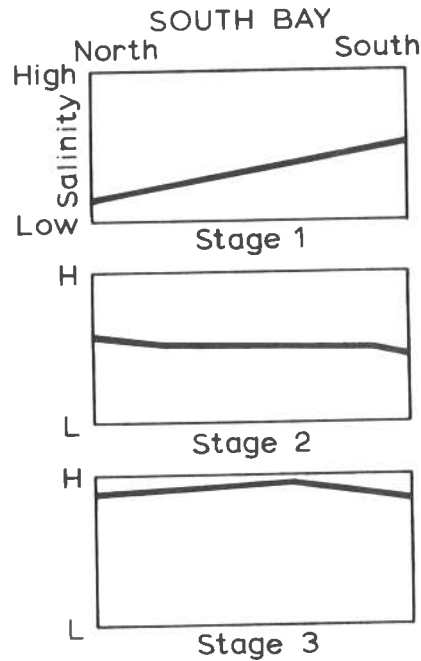

Figure 5.—Generalized surface salinity model for south San Francisco Bay. Stage 1 is the time of high Sacramento River discharge (Dec.-Feb.), stage 2 represents the period of decreasing discharge (March-May), and stage 3 is the period of low Sacramento River discharge (June-Nov.).

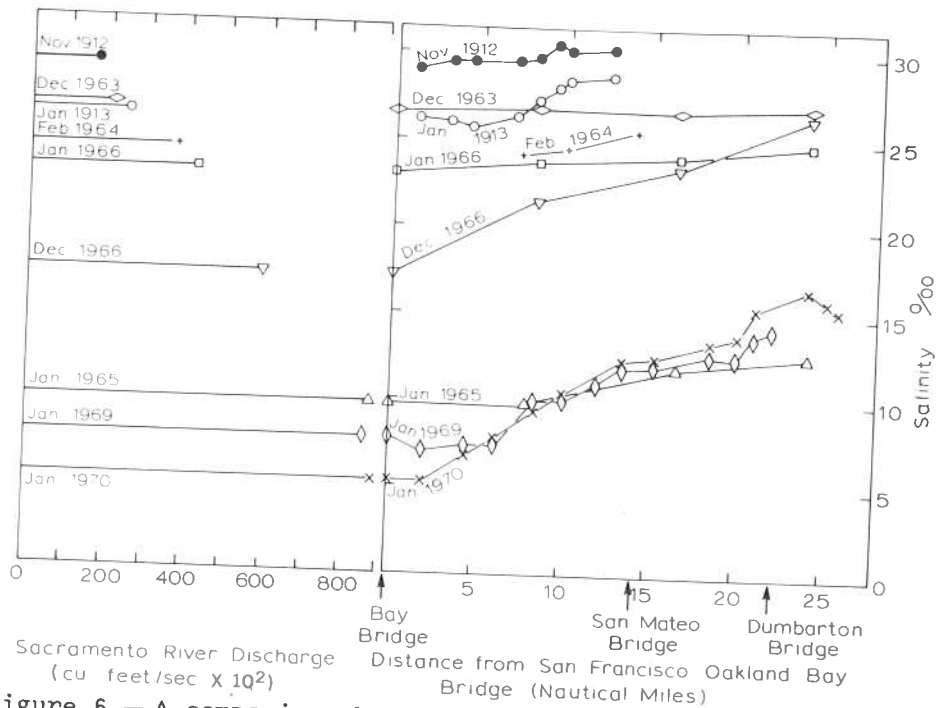

Figure 6.—A comparison between the discharge of the large winter storms in wet and dry years and the corresponding distribution of surface salinities in the south bay.^{4, 17} The size of the winter storms largely governs the wetness or dryness of the year. Thus, the small storm discharges at the top generally correspond to dry years, and the larger discharges at the bottom generally correspond to wet years.

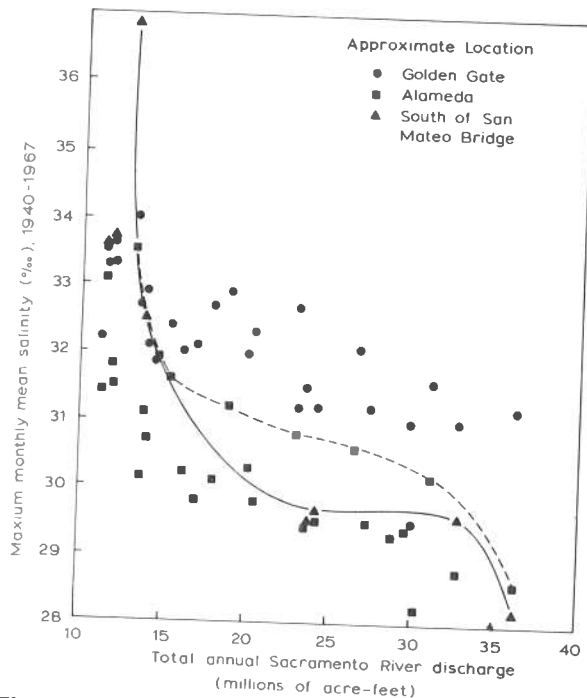

Figure 7.—The highest monthly average salinity for each year during 1940-67 for two stations in the south bay and at the Golden Gate plotted against the total annual discharge for that year.¹⁸ In wet years, the salinities are low, but in dry years, the salinity can equal or exceed the salinity of the adjacent ocean.

These data are also relevant to flushing, and are reconsidered in a later discussion.

Thus far we have described changes in salinity of the bay as related to changes in Sacramento discharge without considering the way in which the discharge causes the salinity change. The following is a generalization of the estuarine circulation in San Francisco Bay. These processes are complicated and poorly known.¹⁹ When Sacramento River water enters the bay it has a hydraulic head that enables it to flow down the estuary. Because of its lower salinity, the incoming river water is less dense than the water in the estuary, and it flows on top of the more saline water. As the low salinity water moves seaward it is subjected to turbulence from tidal currents and winds that mix it with the underlying water. The tidal currents carry the water forward and backward along the estuary, but the surface water has a net movement toward the ocean due to the net effect of the hydraulic head, and to horizontal forces produced by the salinity (density) gradient within the surface water. At the same time there is net movement of the underlying more saline water back up the estuary beneath the low salinity surface water. For simplicity these net movements can be called net surface and net bottom currents.²⁰

Of the above, the size of the discharge (i.e., the hydraulic head and the amount of freshwater available to dilute the water in the estuary) and the net surface and bottom currents are often important in determining salinity changes. Tidal action is also extremely important in transporting and mixing the water within the bay, but it is relatively constant throughout the year. Thus, although tides affect the response time to changes in the freshwater inflow, they are not responsible for seasonal salinity variation.²¹ Wind mixing can be important,²² but at the scale of the gross changes we are considering, it can be neglected.

Some feeling for the extent to which the tide can be effective in mixing low salinity water derived from the Sacramento River with water in the south bay can be obtained by following the edge of the tide as it flows south into the south bay. For about one half hour before the tide runs into the south bay low salinity water from San Pablo Bay, which is sometimes highly turbid, enters the north end of the south bay.²³ When the tide turns, this San Pablo Bay water is transported southward; the low salinity turbid water can be followed for at least ten miles south of the Bay Bridge (Figs. 8 and 9).²⁴

The net surface and net bottom currents which may be presumed on the basis of the observed salinity distribution are shown in a highly diagrammatic form on Figure 10. The three stages represented for the entire estuary are the same three stages outlined earlier in the south bay salinity model (Fig. 5). Throughout all stages the net current pattern does not change in the central and northern bays.

Because the south bay is an appendix-like feature of the estuary, lacking its own through-going drainage, its circulation is quite different from circulation in other parts of the estuary. During maximum Sacramento River discharge (stage 1, Fig. 10) the observed salinity distribution indicates that net bottom currents flow toward the central bay. This circulation pattern may last several months. These are



Figure 8.—A view looking north at the edge of the turbid low salinity water that is carried into the south bay by the tide. Note Hunters Point and San Francisco on the left, the Oakland Bay Bridge in the background and Alameda on the right.

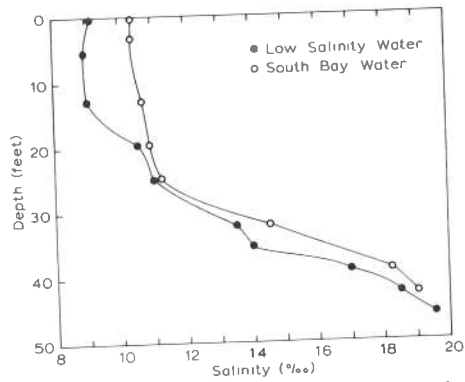
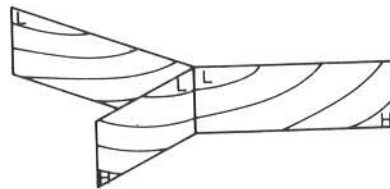
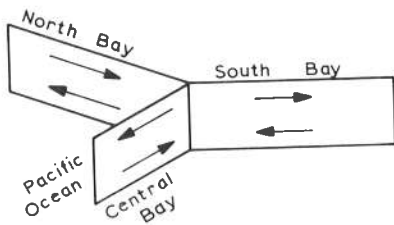

Figure 9.—Measurements of the salinity made in front of, and just behind, the edge of the low salinity flow. Note that the low salinity water is clearly distinct from the south bay water to a depth of about 20 feet.

Surface and bottom currents

Salinity gradient



Stage 1—Maximum Sacramento River discharge
Duration approx. $\frac{1}{4}$ year

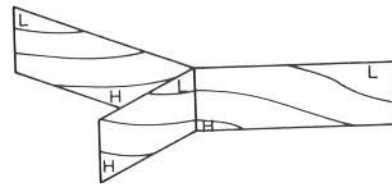
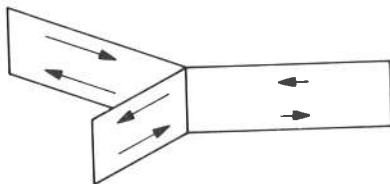

Stage 2—Decreasing Sacramento River discharge
Duration approx. $\frac{1}{4}$ year

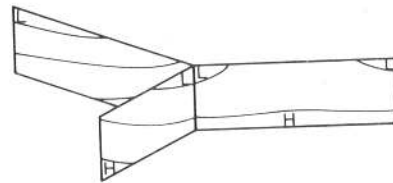
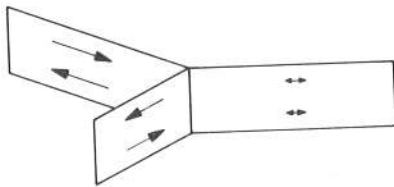

Stage 3—Low Sacramento River discharge
Duration approx. $\frac{1}{2}$ year

Figure 10.—A highly diagrammatic model of the salinity gradients and net surface and bottom currents through the major seasonal stages in the San Francisco Bay estuary. The curved lines on the right-hand figures indicate salinity contours; H indicates high and L indicates low salinity.

probably the most rapid net currents in the south bay, for the strength of these net currents depends in part upon the size of the horizontal salinity differences present--which are greatest during this stage. As the Sacramento River discharge decreases (stage 2) the south bay salinity gradient reverses and the net surface and net bottom currents run in the opposite direction, and are of lower magnitude. This pattern may also last several months. Throughout the remainder of the year (stage 3), when there is almost no salinity gradient in the south bay, the net currents are probably extremely small and ineffective and their directions may vary.

The inferred pattern of net currents is supported for the central and northern bays by preliminary results of a study of the near-bottom currents.²⁵ Weighted plastic markers designed to move with near-bottom water were released in San Francisco Bay and along the adjacent Pacific Coast. Arrows drawn from release points to recovery locations show net bottom current movement from the Pacific Ocean and from the northern edge of the south bay into San Pablo Bay (Fig. 11). Recoveries from the south bay are so few that they are not a positive test of the proposed net current model. The movement of these markers not only demonstrates the existence of net bottom currents but also indicates the paths that will be followed by fluids or solids that are entrained in these currents.

FLUSHING OF THE SOUTH BAY

With the exception of salinity increases due to evaporation, changes in the seasonal salinity distribution described in the foregoing must result from the movement of salt into and out of the south bay. The magnitude of the changes, which indicate the volume of water exchanged, the time distribution of the salinity changes, and the net surface and bottom currents, can be combined to form a generalized picture of the seasonal and yearly flushing pattern of the south bay.

For example, if one considers the year 1969-1970 shown in Figures 3 and 4, a large and abrupt salinity change occurred between December and January. During this interval the average salinity of the south bay decreased from approximately 26.5 o/oo to approximately 14 o/oo.²⁶ This salinity change can be used to estimate how much flushing occurred. The lower the salinity of the flushing water, the less need be introduced to produce the observed salinity change. To take an extreme: if the salinity of the flushing water is 0 o/oo, then 47% of the volume of the south bay would have to have been replaced (i.e., 1,034,000 out of 2,200,000 acre feet). The only sources of water that approach 0 o/oo salinity in the south bay are the local streams and the sewage. But their combined maximum annual discharge (165,570 acre feet) is only 7.5% of the volume of the south bay. Comparison with the amount of water needed to flush the south bay reemphasizes the ineffectiveness of the south bay stream and sewage discharge in determining south bay salinity.

A more realistic estimate of the minimum amount of water that must be flushed from the south bay to achieve the December to January salinity change can be made by assuming that the flushing water had a salinity equal to the lowest salinity measured in the south bay. This was 5.3 o/oo, measured in January 1970, at the Oakland Bay Bridge in the southward flowing San Pablo Bay water described above. Flushing water of

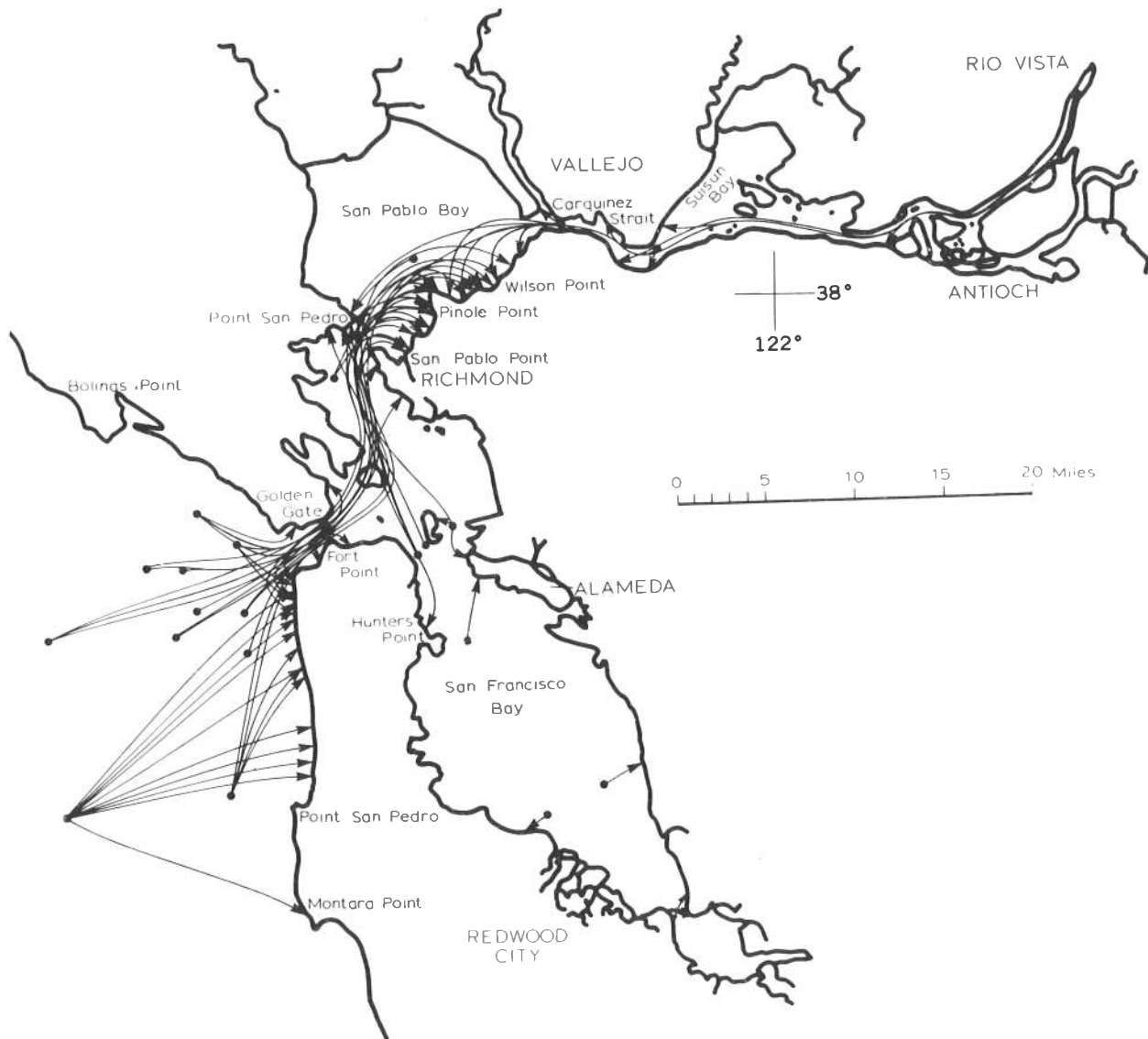

Figure 11.—Arrows drawn from release to recovery points of plastic markers that moved in near-bottom currents.²⁵ Markers were released on March 5 and 6, 1970, and the arrows shown are those that were recovered by April 22, 1970. These arrows indicate the direction of the net bottom currents.

this salinity would require that approximately 59% of the volume of the south bay be replaced. The actual amount of water removed must have been larger, not only because the average salinity of the replacing water was certainly greater than 5.3 o/oo, but also because some mixing of the south bay and flushing water must have occurred during the exchange.

This method of approximating the amount of flushing cannot be applied as reliably for the balance of the year because south bay and flushing water cannot be clearly differentiated when their salinities approach one another.²⁷ However, the seasonal salinity variations in the south bay closely parallel the changes in Sacramento River discharge throughout the year. This is shown on Figure 12, on which the Sacramento River discharge is plotted with discharge increasing downward. Also shown are three curves of the yearly changes in salinity measured at Hunters Point (sta. 23), San Mateo Bridge (sta. 25) and Redwood Creek (sta. 30). The general agreement between the salinity changes and the Sacramento discharge emphasizes their close relation.²⁸

In the foregoing we have discussed salinity changes over a single year. The salinity distribution can also be related in a generalized way to changes in the total annual discharge for the period 1940-1967 shown earlier in Figure 7. In this figure, lines drawn through the highest salinity values at south bay locations show that there was an accelerated decrease of salinity with high annual discharge, and an accelerated increase during years of low annual discharge. Part of the accelerated salinity increase in dry years was due to evaporation, but the effects of evaporation (which goes on in wet, as well as dry years) can become important in increasing salinity only if there is a reduction in the amount of water exchanged in the south bay.

PHOSPHATE²⁹

Like salinity, the annual change in phosphate in the south bay water shows an inverse relation with the Sacramento River discharge. That is, when discharge increases, phosphate decreases, and vice versa. However, phosphate differs from salinity in two important ways. (1) Salt is introduced from the north, whereas phosphate is introduced into the south bay primarily in sewage effluent discharged into the south bay. (2) Salinity is conservative, that is, its concentration is determined primarily by mixing and current transportation, whereas phosphate is non-conservative, and its concentration is further controlled by biological and geochemical processes. Therefore, the accumulation of phosphate indicates that the supply exceeds removal, and the removal indicates the net effect of flushing and consumptive processes.

The annual phosphate distribution (Fig. 13) indicates a dominant source of phosphate at the south end of the south bay (San Jose sewage).³⁰ Sewage from the other major dischargers (San Francisco and Oakland) located near the north edge of the south bay, apparently is dispersed northward from the south bay.

The annual variation in phosphate parallels the annual salinity variation (compare Figure 3). Salinity and phosphate levels are low in late spring, then both climb, reaching peak concentrations late in the year. Then the salinity and phosphate concentrations undergo a rapid

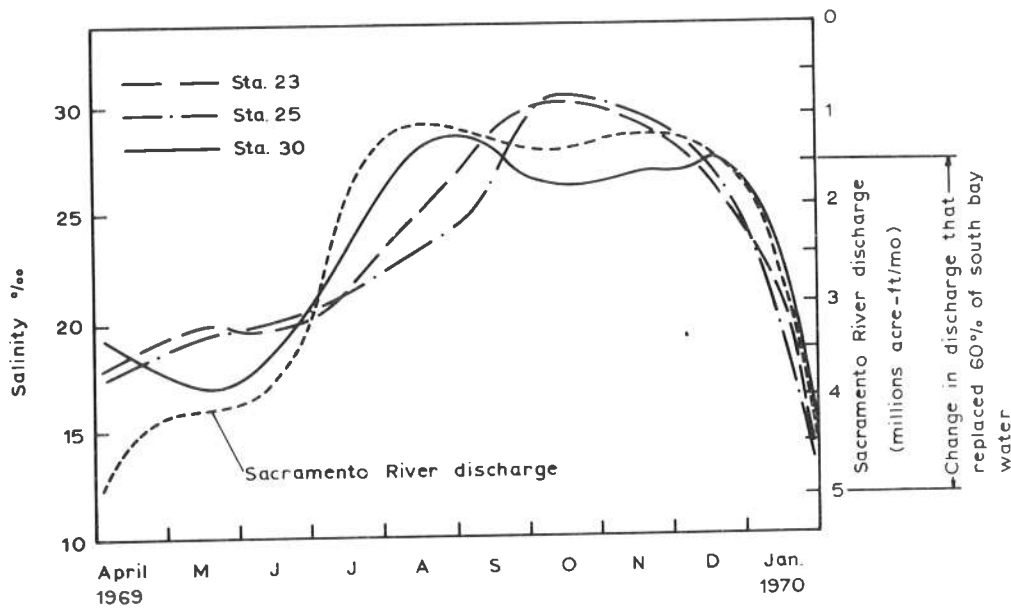

Figure 12.—Seasonal salinity changes at three south bay stations, and the Sacramento River discharge (the latter is shown with discharge increasing downward). Note the general correspondence between the changes in salinity and the discharge.

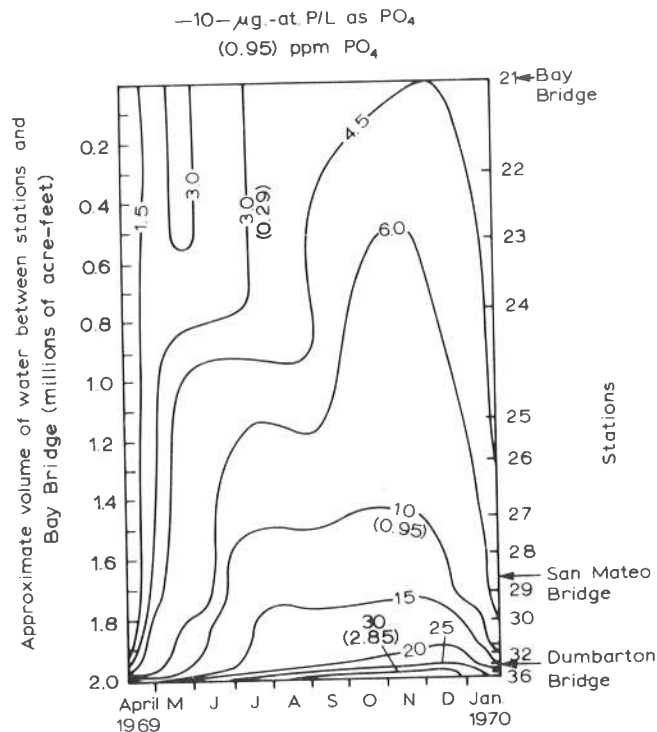

Figure 13.—Seasonal distribution of phosphate (in microgram atoms of phosphorus per liter as phosphate and parts per million phosphate) in south San Francisco Bay. As in figure 3, the stations are located on the basis of the volume of water that lies between the station and the Oakland Bay Bridge.

decrease during the major increase in Sacramento River discharge between late December and January.

The amount of flushing that occurred between December and January can be estimated from the change in phosphate concentration as it was for the change in salinity.^{31, 32} Using the lowest phosphate value measured in January in the south bay (2.6 micro gram atoms/liter) as the phosphate concentration of the flushing water, the amount required to produce the observed change in the south bay concentration from the December average of 11.0 to the January average of 6.3 $\mu\text{g.-at./L}$ would mean that 56% of the volume of the south bay water was replaced. This agrees with the 5% flushing volume computed from the salinity. Because phosphate is not strictly conservative, better agreement between the flushing volumes computed from the phosphate and salinity data would be fortuitous.

Before interpreting the changes in phosphate levels throughout the year in terms of flushing, two factors must be considered: (1) when and how much phosphate was removed by biologic and nonbiologic agents, and (2) when and how much phosphate was supplied to the south bay?

The removal of phosphates to bottom sediments is not evaluated in this report. The seasonal loss of sediment-associated phosphate that accumulates on the bottom of the south bay is not known. The rate of organic growth (phytoplankton) can produce significant changes in phosphate concentration that must be considered. In general phytoplankton growth increases during one or more blooms of weeks in duration, in the period of high duration and intensity of sunlight. This can be followed by a rapid decrease in phytoplankton growth. There has been some study of phytoplankton growth in the northern part of San Francisco Bay,³³ but little is known about the magnitude or the time at which blooms occur in the south bay.

The amount of phosphate supplied to the south bay is difficult to estimate. The only measurements of phosphate in sewage effluent available to the authors are from the city of San Jose.³⁴ If, as it appears, San Francisco and Oakland contribute little sewage that remains in the south bay, then San Jose sewage is quantitatively important. The city of San Jose contributes approximately 40% of the balance of the sewage discharged into the south bay.³⁰ The monthly amount of phosphate in San Jose sewage is shown on Figure 14 along with changes in phosphate measured at Hunters Point (sta. 23), San Mateo Bridge (sta. 25) and Redwood Creek (sta. 30). The higher phosphate concentration at the southern stations reflects the southern source.

The cumulative curve of the phosphate supplied to the south bay (Fig. 14) indicates that if the south bay was not flushed and phosphate was not removed by biological consumption and sedimentation, phosphate would increase. Thus the observed decrease in phosphate concentration that coincides with the high runoff period indicates rates of flushing and biologic and nonbiologic removal in excess of rates of supply. Therefore, the change in phosphate concentration, as well as the change in salinity is related to the changes in Sacramento River discharge.

The change in the Sacramento River discharge parallels the change in phosphate concentration at Redwood Creek (sta. 30). The

relation of the discharge to the phosphate concentration at Station 30 suggests that flushing exerts a considerable influence on the amount of phosphate in the south bay regardless of biologic and nonbiologic removal of phosphate. Because this station 30 is well at the south end of the south bay on a volume basis, it appears that the Sacramento River discharge has a large effect over the entire south bay.

Flushing by Sacramento River inflow and consumption by phytoplankton may effectively remove the phosphate dissolved in south bay waters. In the winter and spring, flushing increases, whereas in the late spring and summer, biological consumption probably increases. Both the steady increase in phosphate concentration from April to July, and the major winter decrease, strongly indicate that phosphate removal is primarily a consequence of flushing.

As shown on Figure 14 the phosphate concentration does not change greatly between late July and early December. In 1969, when the Sacramento River discharge ⁵ was at about one million acre feet per month from July through November, phosphate remained relatively constant indicating that phosphate was being removed as rapidly as it was being supplied. The summer discharge was higher in 1969 than the average for the years 1950 through 1967 (Fig. 15).³⁵ If Sacramento River discharge contributes significantly to flushing of the south bay at these low flow levels, then in years with average runoff the phosphate concentration may be higher in the south bay.

Our data show that the summer accumulation and subsequent winter removal of phosphate in the south bay is highly suggestive of a seasonal modulation of the flushing rate. There is no evidence for a corresponding seasonal modulation of the tides.³⁶ However, the correspondence between the seasonal variation in the observed phosphate concentrations and changes in the Sacramento River discharge argues for a cause and effect relation between river discharge and flushing.

SUMMARY

(1) The seasonal salinity variation of the south bay is largely controlled by fresh water from the Sacramento River under present conditions and is nearly unaffected by the comparatively minor discharge of south bay streams and sewage.

(2) The observed seasonal change in the phosphate concentration in the south bay does not appear to be explained by tidal flushing. The change in phosphate concentration does, however, correspond with the seasonal change in the Sacramento River discharge. Apparently changes in net flow of fresh water to the bay from this source is an important controlling factor in flushing of the south bay.

(3) The indicated relation between the Sacramento River discharge and flushing suggests that soluble waste materials are removed from south bay largely during periods of high river discharge.

(4) Investigations now in progress should further refine this qualitative description of the flushing of south San Francisco Bay and the seasonal salinity and circulation pattern in the estuary.

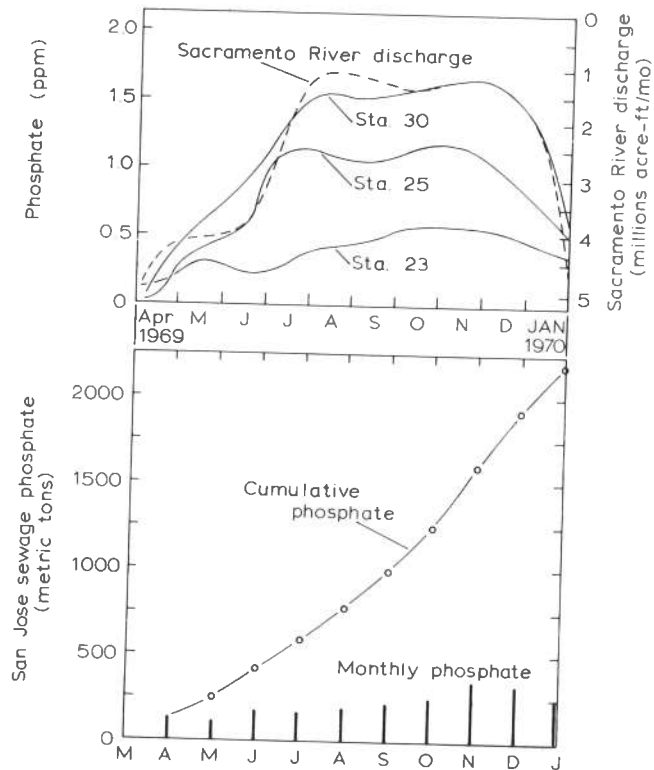

Figure 14.—Upper, Seasonal phosphate changes at three south bay stations and the Sacramento River discharge (the latter is plotted with discharge increasing downward). Lower, The amount of phosphate (metric tons) contributed each month (shown as the monthly phosphate) and the cumulative amount) to the south bay from the San Jose city sewage plant.³⁴

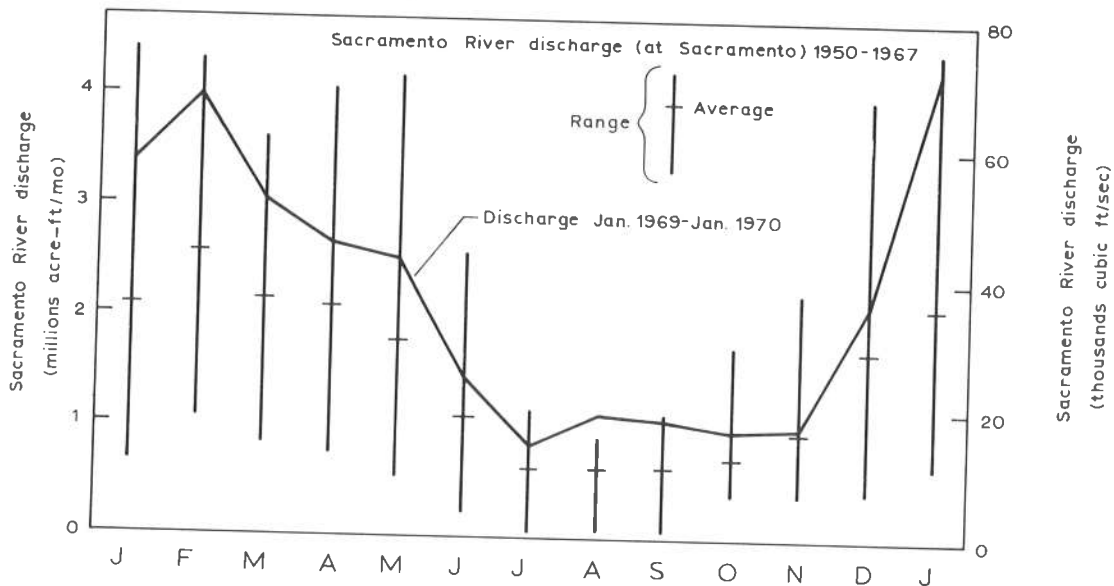

Figure 15.—A comparison between the monthly discharge of the Sacramento River (at Sacramento) from January 1969 to January 1970 and the average and the range of monthly discharge of the Sacramento River (at Sacramento) from 1950 to 1967. Note that July through October was wetter than the average and even higher than the previous August range.

APPENDIX

1. As used in this report, the term flushing refers to the removal of a parcel of water, with its contained constituents, from a given area.
2. The San Francisco Bay estuary has received considerable study. See for example:
 - (a) Selleck, R. E., Pearson, E. A., Glenne, Bard, and Storrs, P. N., 1966, Physical and hydrological characteristics of San Francisco Bay, v. 4 of A comprehensive study of San Francisco Bay--Final report: Sanitary Eng. Research Lab., California Univ., Berkeley, SERL Rept. 65-10.
 - (b) McCarty, J. C., and Harris, H. S., 1967, The future of an estuary: Natl. Symposium on Estuarine Pollution, Stanford Univ., Stanford, Calif., 1967, Proc., p. 335-369.
 - (c) Federal Water Pollution Control Administration, 1967, Effects of the San Joaquin Master Drain on water quality of the San Francisco Bay and Delta: Central Pacific Basins Comprehensive Water Pollution Control Proj. rept.
 - (d) Kaiser Engineers, 1969, San Francisco Bay-Delta water quality control program--Final report (prelim. ed.) to the State of California, 360 p., plus app.
3. Roden, G. I., 1967, On river discharge into the northeastern Pacific Ocean and the Bering Sea: Jour. Geophys. Research, v. 72, no. 22, p. 5613-5629. Also see page 89 of article cited in 2 (a) above.
4. Sources of salinity data:
 - (a) 1912-1913. Sumner, F. G., Louderback, G. D., Schmitt, W. C., and Johnston, E. C., 1941, A report upon the physical conditions in San Francisco Bay, based upon the operations of the United States Fisheries Steamer "Albatross" during the years 1912 and 1913: California Univ. Pubs. Zoology, v. 14, no. 1, 198 p.
 - (b) 1921-70. U.S. Coast and Geodetic Survey, unpublished data for: Fort Point (1921-present), Hunters Points (1945-6 and 1951-56), and Alameda (1939-present).

- (c) 1963-4. Storrs, P. N., Selleck, R. E., and Pearson, E. A., 1965, Appendices to a comprehensive study of San Francisco Bay 1963-1964: Fourth Annual Report SERL Rept. No. 65-2, Univ. Calif., Berkeley, p. B-38-9.
- (d) 1963-5-6. Aplin, J. A., 1967, Biological survey of San Francisco Bay, 1963-1966: California Dept. Fish and Game, Marine Resources Operations Lab. rept. 67-4.
- (e) 1969-70. Measurements by the U.S. Geological Survey, using an electrodeless induction salinometer.

5. The discharge given as Sacramento discharge includes the discharge of the major tributaries to the bay in the Sacramento and San Joaquin basins. Discharges were measured at U.S. Geological Survey gaging stations on the Sacramento River at Sacramento, San Joaquin River at Vernalis, Mokelumne River at Woodbridge, Cosumnes River at McConnell, Calaveras River at Jenny Lind, Dry Creek at Galt.

No measurements were made of actual discharge from the Delta to the Bay because of technical difficulties involved in determining the fresh water component of two-phase flow in tidal reaches. (see: Smith, Winchell, 1969, Feasibility study of the use of the acoustic velocity meter for measurement of net outflow from the Sacramento-San Joaquin delta in California: U.S. Geol. Survey Water-Supply Paper 1877, 54 p.) Despite the lack of an exact measure of the discharge from the Delta, the fresh water flow data are considered to be sufficiently representative for the qualitative discussions in this report.

South bay discharge includes Colma Creek, Redwood Creek, San Francisco Creek, Matadero Creek, Saratoga Creek, Guadalupe River, Patterson Creek (Alameda), San Lorenzo Creek.

- 6. "... The Southern Estuary now exhibits the most serious reduction of benthic animal diversity due to toxicity and the highest levels of nutrients. Both phenomena are associated at least in part with an insufficiency of tidal exchange and flushing flows to dilute the municipal and industrial effluents now discharged to the area. The Northern Reach receives sufficient inflow from the Delta in conjunction with dilution from tidal exchange to dilute waste effluents discharged to that area..." Biologic Ecologic Study, 1968, State of Calif. State Water Quality Control Board, Final Report, Task VII-Ib, p. v-9.
- 7. The relation between Sacramento River discharge and the salinity of the south bay was pointed out in Peterson, D. H., and Carlson, Paul, 1968, Influence of runoff on seasonal changes in salinity

in San Francisco Bay, California [abs.]: Am. Geophys. Union Trans., v. 49, p. 704.

8. Since 1968, the Office of Marine Geology and the Water Resources Division of the U.S. Geological Survey have carried on an investigation of the geology and coastal hydrology of San Francisco Bay. Study has been directed toward 1) the bedrock basin and overlying sediments and 2) the modern depositional environment. The principal aim of the latter is to understand the relation between the chemistry and circulation of the bay water, and the origin, transportation, and deposition of the suspended and bottom sediments. Monthly sampling at reoccupied stations since January 1969, has included: 1) Salinity, conductivity, temperature, turbidity (percent light transmission). All measured throughout the water column. 2) Water samples (2 meter depth) examined for suspended particles, silicate, phosphate, nitrate, nitrite, dissolved and particulate carbon.
9. Salinity is the total amount of dissolved material in grams contained in one kilogram of seawater. Our salinity measurements were made with a field salinometer with an accuracy of about 1 part per thousand.
10. Lynn, R. J., 1967, Seasonal variation of temperature and salinity at 10 meters in the California Current: Calif. Coop. Fisheries Invest. Reports, v. 11, p. 157-174.
11. Evaporation increases steadily from a low (1.3 in) in January, to a high (7.3 in) in July, then decreases to a low (1.3 in) in December. The total (mean annual) evaporation is 47.8 in. (Reference cited in 2a).
12. The maximum potential sewage discharge of the existing south bay sewage treatment plants is approximately 60,000 acre feet per month. (San Francisco Bay Conservation and Development Commission, 1967, Water pollution and San Francisco Bay: San Francisco Bay Conser. and Devel. Comm. rept.
13. Porterfield, G., Hawley, N. L., and Dunnam, C. A., 1961, Fluvial sediments transported by streams tributary to San Francisco Bay area: U.S. Geol. Survey. (Rept. prepared for U.S. Army Corps of Engineers, San Francisco Dist.).
14. The discharge is highly regulated by water management facilities, but the peak discharges controlled by these facilities that do enter the bay are related to the winter rainfall and later snowmelt.
15. The volume of the water between any station and the Oakland Bay Bridge was approximated from the volume distribution given in the reference cited in 2a above.
16. Salinity o/oo Dec. 19, 1969, and Jan. 27, 1970.

Station	Feet below surface	Depth (feet)							
		8	16	24	32	36	40	48	60
Salinity o/oo Dec. 19, 1969									
21	27.1	27.2	27.2	27.2	27.2	--	27.2	27.3	--
23	27.1	27.1	27.2	27.3	27.4	--	27.5	--	--
26	27.2	27.3	27.4	27.5	--	27.6	--	--	--
28	26.8	26.9	26.9	27.0	--	27.1	--	--	--
30	26.8	26.8	26.7	26.7	26.8	--	26.8	26.9	--
32	25.2	25.3	25.6	26.1	--	--	--	--	--
34	25.1	25.2	26.0	--	--	--	--	--	--
36	24.5	24.5	24.7	25.0	--	--	--	--	--
Salinity o/oo Jan. 27, 1970									
21	5.3	5.3	5.7	--	12.3	--	14.0	--	25.0
22	5.3	6.0	7.9	10.6	--	--	--	--	--
23	6.9	7.0	7.8	8.0	9.1	--	16.3	17.1	--
24	9.2	8.8	10.3	--	13.0	--	19.5	--	--
24a	10.4	10.3	10.7	--	14.0	19.0	--	--	--
25	9.6	10.5	10.5	13.0	16.2	--	--	--	--
26	10.6	10.6	12.0	14.0	16.3	16.4	--	--	--
28	12.5	12.5	12.6	--	14.0	--	16.4	16.5	--
29	12.7	12.7	12.8	--	14.8	--	16.5	16.7	--
30	13.5	13.5	13.5	15.0	15.8	--	16.6	16.8	--
31	14.9	14.9	15.0	--	16.2	--	16.5	16.5	--
32	15.5	15.5	--	15.8	16.2	--	16.6	--	--
34	16.6	--	16.6	16.6	--	--	--	--	--
35	16.0	16.0	16.1	--	16.2	16.3	--	--	--
36	15.6	15.6	--	15.7	--	--	--	--	--

17. The Sacramento River discharge used is the average discharge for the three weeks preceeding the time at which the salinity was measured.
18. Data from 1) Sanitary Engineering Research Laboratory; University of California, Berkeley, Assorted publications, 1958-64, and 2) U.S. Coast and Geodetic Survey: unpublished data.
19. The general character of circulation patterns vary between estuaries and quite often vary within estuaries, both spatially and seasonally. The basic factors in determining the type of circulation are (1) the relative interactions and magnitudes of the river discharge and the tidal currents, (2) the physical dimensions of the estuary, and (3) the effect of the earth's rotation (Coriolis force). Two general descriptions of physical processes of estuarine circulation are by Bowden, K. F., 1967, Circulation and diffusion, p. 15-36 in Lauff, G. H., ed., Estuaries: Am. Assoc. Adv. Sci. Pub. 83. Pritchard, D. W., 1967, Observations of circulation in coastal plain estuaries, p. 37-44 in Lauff, G. H., ed., Estuaries: Am. Assoc. Adv. Sci. Pub. 83.
20. These are broad inferences to the nature of the circulation from salinity determinations and comparison to other estuarine systems; long term current measurements will be needed to evaluate the net current velocities.
21. "...Tidal currents, which alone do not result in any net transport of water over a complete tidal period, exert a profound influence through the turbulent mixing they produce. This tends to break down the interface between the river water and salt water and produce a mixing of the two waters..." Bowden, K. F., p. 16, cited in 19 above.
22. "...It is apparent that the wind can have an important influence on estuarine circulation and mixing. Through the stress exerted on the surface it can produce a net transport of water, and the waves generated will increase the intensity of vertical mixing. In the surface layer the water transport will be mainly in the direction of the wind, so that the normal seaward flow will be increased if the wind is blowing down-estuary; it will be decreased, or even reversed in direction, if the wind is up-estuary. Compensating currents occur which influence the flow in the deeper layer also. The increased mixing because of wind currents and waves may have an important effect on the salinity structure, causing a breakdown in the normal pattern of stratification..." from Bowden, K. F., p. 34-35 cited in 19 above.
23. Smith, B. J., 1966, The tides of San Francisco Bay: San Francisco Bay Conserv. and Devel. Comm. rept.

24. Rhodamine dye was air-dripped at five places within this water mass about 1000 feet behind its advancing edge. The dye spots were rapidly elongated parallel to the direction of movement of the flow (i.e., perpendicular to the edge). Thus the water is moving faster and accelerating toward its advancing edge. It must then roll under as the plume overrides south bay water.
25. Chapter B of this report.
26. The average salinity was calculated from the cross section shown on figure 4, and the data were weighted for the volume of water between the measuring stations and the Oakland Bay Bridge (see 2a above).
27. Any dissolved constituent that can be considered to be conservative can be used to estimate the volumes of two different water types in a mixture if the concentration of the constituent is significantly different in the two water types.
28. The Sacramento River discharge is superimposed on the salinity curve in such a way as to make the observed change in salinity that occurred before December and January coincide with the change in Sacramento discharge for the same period. The discharge curve is drawn from the data given in figure 3, with the exception that the December discharge is reduced by interpolation to account for the fact that most of the discharge increase in December occurred after the sampling cruise.
29. Phosphate samples were collected as in 8 above. The concentration of hydrolyzable and orthophosphate in the samples was determined by an automated adaptation of the Fiske and Subbarow procedure using 1-amino-2-naphthol-4-sulfonic acid (ANSA) as a reducing agent for phosphomolybdic acid. 'Inorganic Phosphate', Technicon Laboratory Method File N-4b, Technicon, Inc., 1965. (Technicon Controls Inc., Chauncey, N.Y.).
30. A 1967 spot check by the BCDC (Water Pollution and San Francisco Bay) of sewage discharge into the south bay showed that the San Jose discharge (62 million gallons per day) was 38% of the total daily discharge (163.3 mgd) excluding the discharge from Oakland and the southeastern San Francisco plant. Of this 163.3 mgd, 86% (140 mgd) was discharged south of the San Mateo Bridge.

31. A nonconservative element can be used to indicate flushing when the amount of change in the concentration of the element can be shown to greatly exceed the expected amount of removal by biological consumption. Assuming an average depth of 6 meters, and using a commonly accepted ratio of carbon to phosphorous utilization of 106:1 by atoms (Redfield, Ketchum, and Richards, 1963) the change in phosphate from December to January would require 120 grams of carbon per square meter per day. Such a rate of phosphatic utilization of carbon is 10 to 100 fold greater than the highest expected rates in the most fertil natural environments (Ryther, 1963). Thus the large change in phosphate between December and January must be largely due to flushing.
- (a) Redfield, A. C., Ketchum, B. H. and Richards, F. A., 1963, The influence of organisms on the composition of sea water, p. 26-77 in Hill, M. N., ed., The Sea: Vol. 2, John Wiley and Sons, New York.
- (b) Ryther, J. H., 1963, Geographic variations in productivity, p. 347-380 in Hill, M. N., ed., The Sea: Vol. 2, John Wiley and Sons, New York.
32. The phosphate concentration measured at two meters was taken as representative of the water column at the station. Average phosphate for the entire south bay was then calculated weighting each station for the volume of water between it and the Oakland Bay Bridge (see 2 above).
33. See for example:
- (a) Bain, R. C., and McCarty, J. C., 1965, Nutrient productivity studies in San Francisco Bay: U.S. Public Health Service, Central Pacific Basins Water Pollution Control Proj. Tech. Rept. 65-1.
- (b) Peterson, D. H., Carlson, P. R., and McCulloch, D. S., 1970, Photosynthetic utilization of dissolved silica and production of suspended particles, San Francisco Bay estuary /abs./: EOS (Am. Geophys. Union Trans.), v. 51, no. 4, p. 318.
34. Phosphate data (effluent total phosphorus) courtesy of Mr. Harry Sanders, senior chemist, San Jose, Santa Clara Sewage treatment plant. Monthly discharge data are from unpublished monthly report from the same source.

35. On this figure, the discharge of the Sacramento River is as measured at Sacramento.

36. U.S. Coast and Geodetic Survey, 1969, Tidal current tables, Pacific Coast of North America and Asia, 254 p.

U.S. Coast and Geodetic Survey, 1969, Tide tables, West Coast of North and South America, 224 p.

Movement of Seabed Drifters in the San Francisco Bay Estuary and the Adjacent Pacific Ocean: A Preliminary Report

By T. J. Conomos, D. H. Peterson, P. R. Carlson, and D. S. McCulloch

A PRELIMINARY STUDY OF THE EFFECTS OF WATER CIRCULATION
IN THE SAN FRANCISCO BAY ESTUARY

GEOLOGICAL SURVEY CIRCULAR 637-B

*Prepared in cooperation with the
U.S. Department of Housing and
Urban Development*



CONTENTS

	Page
Introduction-----	B1
Methods-----	1
Results-----	1
Discussion-----	4
Appendix -----	7

ILLUSTRATIONS

	Page
Figure 1. Drawing showing side and top view of seabed drifter-----	B2
2. Map showing seabed drifter release locations, 5-6 March 1970-----	3
3. Map showing locations of releases and approximate recovery positions of seabed drifters released in the Pacific Ocean-----	5
4. Map showing locations of releases and approximate recovery positions of seabed drifters released within the bay system-----	6

TABLES

	Page
Table 1. Recovery statistics of seabed drifter releases-----	B4
2. Directional data of seabed drifters -----	4

A PRELIMINARY STUDY OF THE EFFECTS OF WATER CIRCULATION
IN THE SAN FRANCISCO BAY ESTUARY

**Movement of Seabed Drifters in the San Francisco
Bay Estuary and the Adjacent Pacific Ocean:
A Preliminary Report**

By T. J. Conomos, D. H. Peterson, P. R. Carlson, and
D. S. McCulloch

INTRODUCTION

Man's increasing utilization of the San Francisco Bay estuary and the adjacent Pacific coast has made, and will continue to make, it necessary to increase our knowledge of the processes and rates of sediment transport within the San Francisco Bay system and in the nearby coastal Pacific.¹ (Note: numbered items in text are keyed to numbered items in appendix at end of chapter B.) The movement of near-bottom water is of considerable importance in transporting suspended materials between the Pacific Ocean and the San Francisco Bay system. Owing primarily to tidal flow, the movement of near-bottom water may be oscillatory. There is, however, a residual drift.² To describe this residual drift, the U.S. Geological Survey is releasing seabed drifters bimonthly within the San Francisco Bay system and on the continental shelf of central California from Cape Mendocino to Point Conception.

This report presents preliminary results of the first release (5-6 March, 1970) but considers only those seabed drifters released in the Bay system and on the continental shelf within 90 kilometers of the Golden Gate. All releases were made in water depths of less than 180 meters (100 fathoms). Only the direction of residual drift is considered. When recovery data are more complete for this and future releases, the rates of flow will be determined.

METHODS

The seabed drifter used in this study³ closely conforms to that used by investigators on both the

Atlantic and Pacific coasts.^{1,4,5,6,7,8} It consists of a perforated plastic saucerlike disk on a 55-centimeter-long plastic stem, with a 5-gram brass collar attached at its lower end (fig. 1). With the collar the average density of the drifter is greater than that of water. In nonmoving water the stem tip rests lightly on the bottom with the saucer off bottom; in currents the saucer leads the stem in moving downstream, and the drifter tends to lift off the bottom.⁶

The drifters were released within the Bay system from a boat; offshore drifters were released from an aircraft flying at an altitude of 150 m, and at a speed of 150 km per hr. Release locations are shown in figure 2. To assure rapid sinking and minimal transport from other than bottom currents, the drifters are held in clusters of five and weighted by a ring of salt around their stems. The salt weights dissolve within 45 minutes. Groups of drifters in multiples of 25 were released at each station (fig. 2). The releases were completed during the daylight hours on 5 and 6 March, 1970; offshore releases within 30 km of the Golden Gate were made during an ebbing tide. Aircraft release points were located by time and course from the coast and boat releases by navigational (visual and radar) fixes.

RESULTS

Of the 1,345 drifters released, 18 percent (237) were recovered by 22 April 1970 (table 1). Eighteen percent of those released within the Bay system (including the Golden Gate release points) were recovered; 17 percent of those released offshore were recovered. The release and recovery information

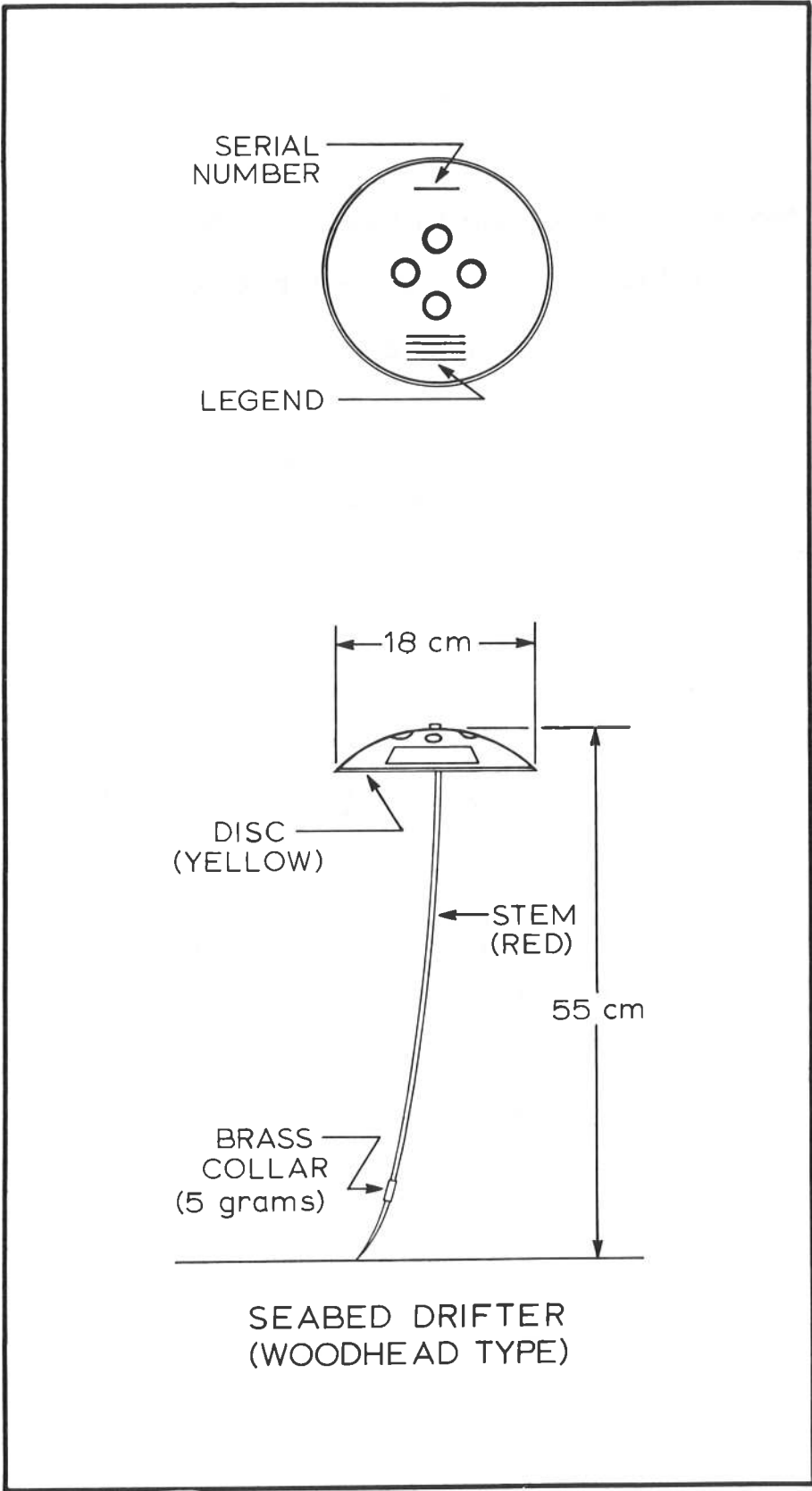

Figure 1.—Side and top view of seabed drifter. Modified from a drawing by J. B. Zocchi.

38°30'

38°00'

37°30'

37°00'

T

T

T

T

T

T

T

T

T

T

T

T

T

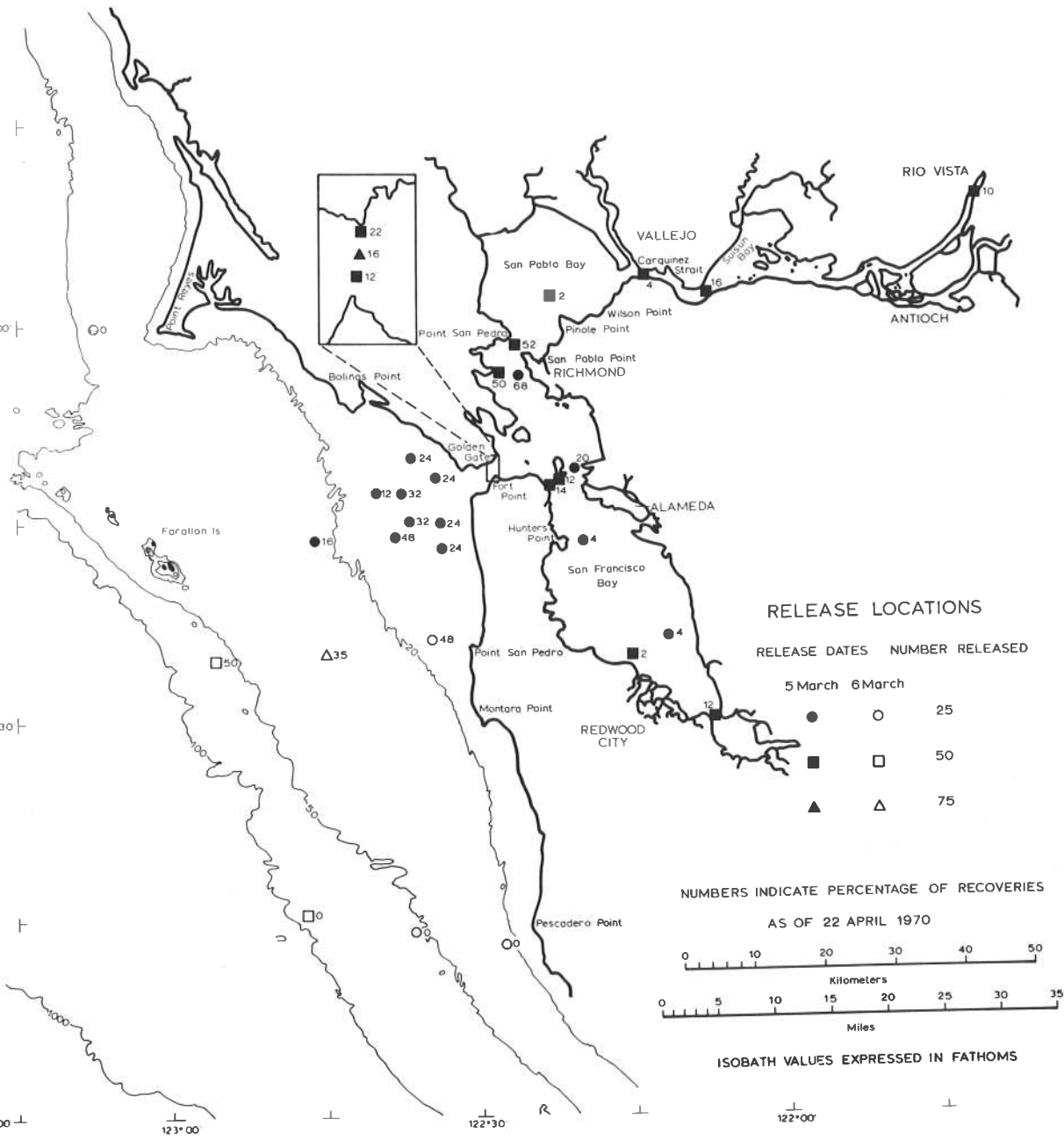

Figure 2.—Seabed drifter release locations, 5-6 March, 1970. The number adjacent to each symbol indicates the percentage of drifters recovered (as of 22 April, 1970) that were released at that location.

Table 1.—*Recovery statistics of seabed drifter releases*

Location	Total number of seabed drifters		
	Released (5 and 6 March, 1970)	Recovered (as of 22 April, 1970)	Recoveries (percent)
Outside bay-----	575	97	17
Inside bay ^a -----	770	140	18
Total-----	^b 1,345	237	18

^a Includes Golden Gate release positions.

^b One release group contained 20 drifters, not the usual multiple of 25.

Table 2.—*Directional data of seabed drifters*

Drifters recovered	Drifters released			
	Outside bay		Inside bay	
	Number	Percent	Number	Percent
Inside Bay-----	57	59	136	97
Outside Bay-----	40	41	^a 4	3
Total-----	97		140	

^a All four were released at the Golden Gate.

for the bottom drifters given in table 2 shows that, of those recovered, 19 percent (44) were found on the ocean beaches seaward of the Golden Gate, and 81 percent (193) were found inside the Golden Gate. The percentage recovery tabulated for each release point is shown in figure 2.

The principal directions of drifter movement are shown in figures 3 and 4. The arrows are drawn from release points to recovery locations typical of that release point. Not all recovery points are shown. Drifters released in the Pacific moved predominately toward the east. Movement of drifters into the San Francisco Bay system (San Pablo Bay) is particularly apparent for offshore releases less than 25 km from the Golden Gate, at which the bottom depth is generally less than 30 m (17 fathoms). Excluding the data from release points at the Golden Gate (inset in fig. 2), no drifters released within the Bay system have yet been recovered on the ocean beaches (fig. 4, table 2).

The Bay system can be divided into three areas on the basis of differing seabed drifter movements (fig. 4).

1. Rio Vista westward to eastern San Pablo Bay: Dominant movement was southwesterly. Typical maximum transport distances are 75 km.

2. Southern San Pablo Bay, northern San Francisco Bay: Dominant movement was to the north and west, with maximum transport distances of 40 km. Recovery was greatest from releases in San Pablo Bay.
3. South San Francisco Bay: Little apparent net movement (< 8 km) and no prevalent direction. The percentage of recovery was lowest in this area.

DISCUSSION

Although the data presented herein represent preliminary results of the initial release, results of similar seabed drifter studies and a basic knowledge of physical processes occurring in this system allow us to tentatively explain several phenomena.

The decrease of drifter recoveries with increasing depth on the continental shelf suggests a net seaward drift that becomes more important farther offshore. Similar drifts have been reported along the middle Atlantic and northwestern continental shelves.^{4,7} Drifters that traveled east were responding primarily to the effect of onshore wave transport. With more recovery data we should also be able to define the direction of longshore drift.

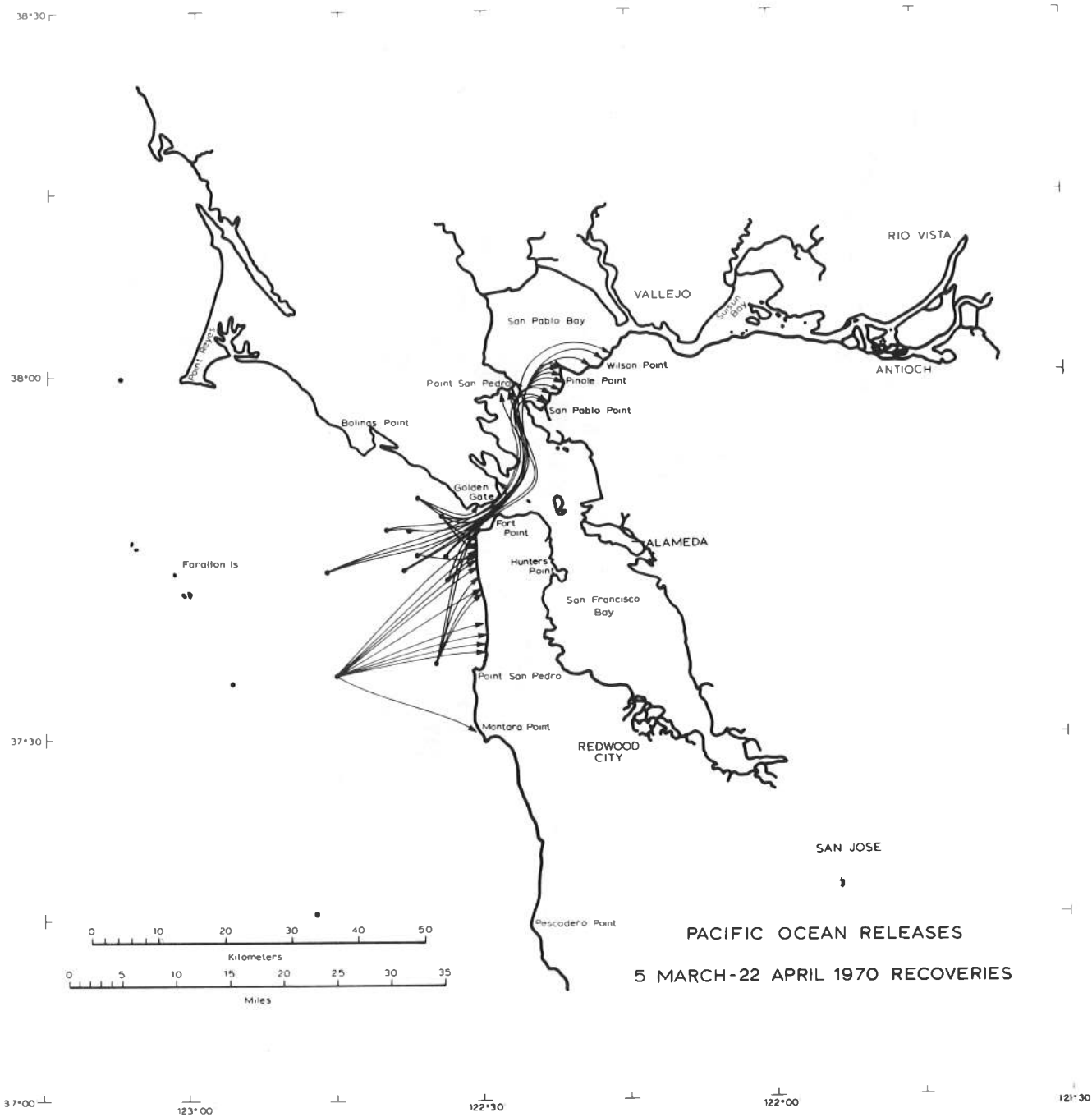

Figure 3.—Locations of releases and approximate recovery positions of seabed drifters released in the Pacific Ocean.

10. Peterson, D. H., and Carlson, P. R., 1968, Influence of runoff on seasonal changes in salinity of San Francisco Bay: *Am. Geophys. Union Trans.*, v. 49, p. 704.
11. Chapter A of this circular.
12. Lager, J. A., and Tchobanoglous, George, 1967, Use of hydraulic and mathematical models for determining effluent diffusion in South San Francisco Bay: *Natl. Symposium on Estuarine Pollution*, Stanford Univ., Stanford, Calif., 1967, *Proc.*, p. 384-422.
13. Meade, R. H., 1968, Relations between suspended matter and salinity in estuaries of the Atlantic Seaboard *in* *Geochemistry, precipitation, evaporation, soil, moisture, hydrometry*—General Assembly of Bern, 1967, Reports and discussions, v. 4: *Internat. Assoc. Sci. Hydrology Pub.* 78, p. 96-109.
14. Meade, R. H., 1969, Landward transport of bottom sediments in estuaries of the Atlantic Coastal Plain: *Jour. Sed. Petrology*, v. 39, no. 1, p. 222-234.